



AMG



# MERCEDES-AMG GT COUPÉ

Price list from 1<sup>st</sup> July to 31<sup>st</sup> August 2024

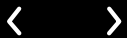

# Welcome

At Mercedes-Benz we appreciate the importance of detail. Over the following pages you'll find model prices and a breakdown of standard and optional equipment, as well as details of the attractive finance offers and benefits that are available to every Mercedes-Benz driver.

We have highlighted some of the best styling features both inside and out, some of the new technology features and some body styling options which all combine to give you a unique driving experience. To experience a full listing of what is available; please speak directly to your local Mercedes-Benz Dealer.

Of course, some things have to be experienced to be truly appreciated, such as the qualities that set a Mercedes-Benz apart, which is why we'd like to invite you for a test drive at your local Mercedes-Benz Dealership. Discover the location and the contact details of your local Mercedes-Benz Dealership at [www.mercedes-benz.ie](http://www.mercedes-benz.ie)



Some of the model features, optional extras and colours shown may not be available, or may only be available in a different specification, or at a different price.

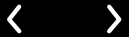

Some of the model features, optional extras and colours shown may not be available, or may only be available in a different specification, or at a different price.

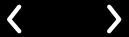

Some of the model features, optional extras and colours shown may not be available, or may only be available in a different specification, or at a different price.

# MODEL PRICES



Petrol							
Model Description	Wheel size	CO2	VRT Rate	Road Tax	CC	BHP	Price*
Mercedes-AMG GT 43 Coupé	19"	191 +	41.00%	€2,400	1991	421	€224,955
Mercedes-AMG GT 63 4MATIC + Coupé	20"	191 +	41.00%	€2,400	3982	585	€348,910

\*Prices applicable to all models registered from 1st July to 31st August 2024 . Subject to availability. Terms & Conditions apply. Prices quoted do not include dealer and delivery related charges. Owing to supply shortages, options for vehicles may be temporarily restricted, resulting in modified vehicle and/or package pricing



Mercedes-AMG GT

**TECHNOLOGY**

# MERCEDES-BENZ USER EXPERIENCE (MBUX)

Transforming the in-car user experience, thanks to MBUX: Controlled via voice or touch input, the innovative infotainment system can over time even predict personal habits thanks to artificial intelligence.

## Voice control

- Activated by the keywords “Hey Mercedes”, the new intelligent voice control LINGUATRONIC<sup>1</sup> lets you control many of the infotainment functions, including destination input, phone calls or music selection
- MBUX is able to understand different accents and will adjust to you over time
- MBUX even understands indirect commands. Feeling chilly? Just say “I feel cold” and MBUX will adjust the temperature for you

## Touch inputs

- Beside voice control you can operate MBUX via touchscreen, the touchpad on the centre console, as well as touch control buttons on the steering wheel
- The touchpad recognises your handwriting should you wish to enter addresses or phone numbers silently

## Personalisation

- Turn the new Mercedes-AMG GT into your very own Mercedes-Benz by personalising driving modes, radio stations and much more
- Your personal settings can be saved in up to seven different profiles, making your driving experience the best one possible
- Thanks to artificial intelligence, MBUX is able to learn and adapt over time. It will be able to predict your personal habits, such as navigation for frequently-driven routes, or the radio station you like to listen to on your way home from work

## Maintenance and service

- Wondering when the next service is due? Or how much further you can drive until you need to stop at a petrol station? Just ask your MBUX – it will tell you the answer



The connection of the communication module to the mobile phone network including the emergency call system depends on the respective network coverage and availability of network providers

<sup>1</sup>LINGUATRONIC off-board functions are currently only available for three years



# MERCEDES ME CONNECT

Stay connected any time, anywhere.

Mercedes *me*

Mercedes me is a range of innovative online services designed to enhance your Mercedes-Benz experience. Accessible via mobile, tablet or PC, Mercedes me lets you enjoy the highest standards of care and support, in a way that integrates seamlessly with your busy lifestyle.

## **Safety and Service – Mercedes me connect helps to keep you and your car safe**

Check your car's oil level, tyre pressure and fuel from your phone so you'll be ready for every journey.

## **Live Traffic Information, Parked Vehicle Locator and much more with Mercedes me connect**

Forgot where you've parked? Parked Vehicle Locator<sup>1</sup> will show you exactly where your car is as long as you're in a 1.5km radius of where you parked. Real-time traffic data and dynamic route with shorter journey times.

## **Comfort – connect to your car anytime, anywhere**

Forgot to lock your car? With Remote Car Lock<sup>2</sup> you will receive a notification on your smartphone to let you know. With one tap, you can lock and unlock your vehicle so you never have to worry.

The connection of the communication module to the mobile phone network including the emergency call system depends on the respective network coverage and availability of network providers  
<sup>1</sup>Available on all models with the Vehicle Monitoring package. This option may vary between standard and additional cost dependent on the model    <sup>2</sup>Part of the Vehicle Status package. This option may vary between standard and additional cost dependent on the model    Images shown are for illustration purposes only

# MERCEDES-AMG GT COUPÉ



Option shown: high-tech silver

# MERCEDES-AMG GT 63 4MATIC+ Standard equipment highlights



Option shown: spectral blue



Option shown: MANUFAKTUR Patagonia red

### Exterior

(20-inch) AMG 10-twin-spoke light-alloy wheels aerodynamically optimized, painted in tantalite gray with a high-shine finish (RTM)

AMG high-performance compound brake system

AMG Night package

AMG bodystyling

AMG brake callipers painted yellow

Heat insulated, dark tinted glass

LED high performance headlights with adaptive highbeam assist

KEYLESS-GO with seamless door handles

Mirror package

Rear axle steering

Summer tyres

### Engine, Transmission and Suspension

AMG ACTIVE RIDE CONTROL suspension

AMG DYNAMIC PLUS package



<sup>1</sup>Some of the model features, optional extras and colours shown may not be available, or may only be available in a different specification, or at a different price



Ambient lighting in 64 colours



USB package Plus

**Safety and Assistance Systems**

- 360° camera
- Active Lane Keeping Assist
- Blind Spot Assist
- Parking package – Active Parking Assist<sup>2</sup>

**Communications and In-Car Entertainment**

- AMG Track Pace
- Burmester® surround sound system
- MBUX Navigation Premium<sup>3</sup>
- Smartphone integration<sup>4</sup>
- USB package Plus



AMG illuminated door sills with 'AMG' lettering

**Interior**

- Ambient lighting in 64 colours
- AMG illuminated door sills with 'AMG' lettering and exchangeable cover
- AMG Performance steering wheel in nappa leather with flattened bottom section

- AMG SPEEDSHIFT MCT 9G
- Load Compartment package
- Memory package
- Seats – heated front seats

- Seat belts in black
- Steering wheel with AMG buttons
- THERMOTRONIC automatic climate control

**Trim and Upholstery**

- Black Trim
- Nappa leather – black



<sup>2</sup>Our driver assistance and safety systems are aids and do not relieve you of your responsibility as the driver. Please take note of the information in the Owner's Manual and the system limits which are described therein <sup>3</sup>The connection of the communication module to the mobile phone network including the emergency call system depends on the respective network coverage and availability of network providers <sup>4</sup>Compatible mobile phone required

# PERSONALISATION Overview

Paints



Wheels



Upholstery - trim

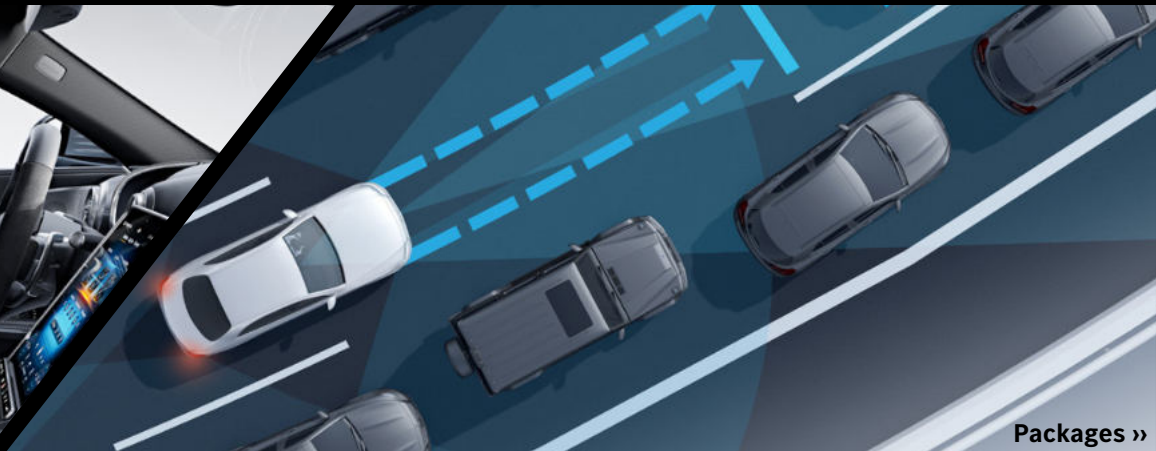

Packages »

# Upholstery highlights



Nappa leather black (801A)  
Standard



Nappa leather sienna brown / black (804A)  
Optional



Nappa leather red pepper / black (807A)  
Optional



Nappa leather sage gray / black (808A)  
Optional



nappa leather / MICROCUT microfibre black (701A)  
Optional



nappa leather / MICROCUT microfibre black (711A)  
Optional

# MANUFAKTUR Upholstery highlights



MANUFAKTUR nappa leather MANUFAKTUR truffle  
brown / black (824A)  
Optional



MANUFAKTUR nappa leather MANUFAKTUR crystal  
white / black (825A)  
Optional



MANUFAKTUR nappa leather MANUFAKTUR  
macchiato beige / titanium gray (835A) Optional

# Interior Trim highlights



AMG trim elements in high-gloss black (H80)  
Standard



AMG aluminium trim (H70)  
Optional



AMG carbon-fibre trim (H73)  
Optional



MANUFAKTUR trim elements in black chrome (H94)  
Optional



# Wheel highlights



(20-inch) AMG 10-twin-spoke light-alloy wheels aerodynamically optimized, painted in tantalite gray with a high-shine finish (RTM)  
Standard



(20-inch) AMG 10-spoke light-alloy wheels aerodynamically optimized, painted in tantalite gray with a high-shine finish (RVN)  
Optional



(20-inch) AMG 10-twin-spoke light-alloy wheels aerodynamically optimized, painted in tantalite gray with a high-shine finish (RWD)  
Optional



(21-inch) AMG 10-twin-spoke forged wheels painted in matt black, rim flange with a high-shine finish (RWE)  
Optional



(21-inch) AMG 5-twin-spoke forged wheels aerodynamically optimized, painted in tantalite gray with a high-shine finish (RWI)  
Optional



(21-inch) AMG 5-twin-spoke forged wheels aerodynamically optimized, painted in matt black, rim flange with a high-shine finish (RWK)  
Optional



(20-inch) AMG 10-twin-spoke light-alloy wheels aerodynamically optimized, painted in tantalite gray with a high-shine finish (RWL)  
Optional



(21-inch) AMG cross-spoke forged wheels painted in matt techgold, rim flange with a high-shine finish (RWM)  
Optional

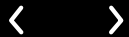

# COLOUR OPTIONS

Non-metallic and metallic paints

No-cost option



**197 obsidian black metallic**



**922 high-tech silver metallic**



**992 selenite grey metallic**



**914 sun yellow non-metallic**



**970 spectral blue metallic**



Please note that, owing to limitations of on-screen representation, paint colours may differ from those shown

# COLOUR OPTIONS MANUFAKTUR paints

○ Cost option



885 MANUFAKTUR opalite white bright



956 MANUFAKTUR alpine grey solid



659 MANUFAKTUR opalite white magno<sup>1</sup>



993 MANUFAKTUR patagonia red bright



593 MANUFAKTUR spectral blue magno<sup>1</sup>



964 MANUFAKTUR hyper blue magno<sup>1</sup>



Please note that, owing to limitations of on-screen representation, paint colours may differ from those shown

<sup>1</sup>MANUFAKTUR magno matt paint finishes require extra care. Please refer to the Owner's Manual for instructions

# PACKAGE OPTIONS - AMG Night Package 2 highlights



Option shown: high-tech silver (922U), 53.3 cm (21-inch) AMG cross-spoke forged wheels (RWL), AMG Night Package (P60), AMG Night Package II (PAZ)

The AMG Night Package II adds further high-class design details to your vehicle: the radiator shell and the Mercedes star at the rear in black chrome transform your vehicle into a real eye-catcher.



- Components:
- AMG-specific radiator shell, darkened with struts in black chrome
  - Model badge on boot lid and wings in black chrome
  - Mercedes star at the rear in black chrome

From \* €1,840

\*Subject to vehicle specification and VRT rate.

# PACKAGE OPTIONS - AMG Aerodynamics Package highlights



Option shown: MANUFAKTUR alpine gray solid (956U), 53.3 cm (21-inch) AMG cross-spoke forged wheels (RWL), AMG Exterior Carbon Package (773), AMG high-performance ceramic composite braking system (B07 ), AMG Aerodynamics Package (B26), AMG Night Package II (PAZ)

With the AMG Aerodynamics package, you can specifically sharpen the looks while benefiting from improved driving characteristics. All elements increase downforce on both the front and rear axles.



### Components:

- Front apron with flics on the air inlets and wheel arches in high-gloss black
- Rear apron with flics on the side air outlets in high-gloss black
- Diffuser attachment at the rear in high-gloss black
- AMG fixed rear wing (U94) in high-gloss black

From \* €7,935

\*Subject to vehicle specification and VRT rate.

# PACKAGE OPTIONS - AMG Exterior Carbon Package highlights



Option shown: MANUFAKTUR opalite white bright (885U), 50.8 cm (20-inch) AMG 10-twin-spoke light-alloy wheels (RTM), AMG Exterior Carbon Package (773)

Design elements made of carbon fiber or in carbon design: high-tech material for real motorsport atmosphere.



### Components:

- Design elements made of carbon fiber
- Inserts on the front splitter
- Trim strip in the side sill panel
- Rear diffuser
- Design elements in high-gloss black
- Trim on the front wings
- Beltline and windowline trim strips
- Exterior mirror housing in carbon fiber design
- Twin tailpipe trim elements in black chrome
- AMG fixed rear wing (U94) made of carbon fiber, also when AMG aerodynamics package (B26) is selected

\*Subject to vehicle specification and VRT rate.

From\* €11,566

# DIGITAL LIGHT

High-definition headlamps with innovative features

The new innovative DIGITAL LIGHT headlamps works like a projector with more than one million pixels per headlamp and responds with brilliant light to changing traffic, road or weather conditions. Its ULTRA RANGE Highbeam with 650 m makes you feel like driving at daylight.

From\* €2,112



Some of the model features, optional extras and colours shown may not be available, or may only be available in a different specification, or at a different price.  
\*Subject to vehicle specification and VRT rate.



# DRIVING ASSISTANCE PACKAGE

The Driving Assistance package<sup>1</sup> contains a range of highly intelligent features to help you stay safe on the road – by making the drive more effortless, by warning of danger, and by taking steps to protect you in an emergency.

**Driving Assistance package<sup>1</sup> (code P20)**

- Active Blind Spot Assist
- Active Distance Assist DISTRONIC
- Active Steering Assist
- Active Stop-and-Go Assist
- Evasive Steering Assist
- PRE-SAFE<sup>®</sup> PLUS and PRE-SAFE<sup>®</sup> Impulse Side

From\* €6,536

<sup>1</sup>Our driver assistance and safety systems are aids and do not relieve you of your responsibility as the driver. Please take note of the information in the Owner's Manual and the system limits which are described therein  
\*Subject to vehicle specification and VRT rate.



# TECHNICAL DATA

- Standard

Model	Mercedes-AMG GT 63 4MATIC+	
<b>Engine</b>		
Total displacement	cc	3,982
Arrangement/cylinders/valves		V/8/32
Power <sup>1</sup>	hp (kW) at rpm	585 (430)/6,500
Torque <sup>1</sup>	Nm at rpm	800/2,500–5,000
Compression ratio		8.6:1
Emissions standard		Euro 6d-ISC-FCM

Transmission
AMG SPEEDSHIFT MCT 9-speed sports automatic transmission

Performance		
Acceleration 0-100 km/h	sec	3.2
Top speed	km/h	315 <sup>2</sup>

Model	Mercedes-AMG GT 63 4MATIC+	
<b>Weights and capacities</b>		
Kerb weight <sup>3</sup>	kg	2,130
Perm. GrossVehicle Weight	kg	2,160
Boot capacity	l	321
Fuel tank capacity/of which reserve	l	70/10
Turning circle	m	12.5

Fuel consumption <sup>4,5,6</sup>		
Combined (consumption dependent on chosen optional equipment)	l/100 km mpg	14.1 20.0

<sup>1</sup>Figures according to Directive 80/1269/EEC in the currently applicable version <sup>2</sup>Electronically limited <sup>3</sup>Mass of the vehicle in running order with at least 90% full fuel tank, plus the mass of the driver (estimated by law at 75 kg), fuel and fluids, equipped with the standard equipment as specified by the manufacturer as well as, where applicable, the mass of the body, cab, trailer coupling and spare wheel(s) as well as tools. Optional extras, additional equipment and accessories can influence the weight, residual payload, rolling resistance, aerodynamics, etc., and therefore also affect the consumption/VRT rate/CO<sub>2</sub> values <sup>4</sup>All figures are based on a standard specification with the smallest tyre size <sup>5</sup>The choice of wheels and transmission may affect CO<sub>2</sub> emissions and corresponding VRT rate. <sup>6</sup>The indicated values were determined according to the prescribed measurement method – Worldwide Harmonised Light Vehicle Test Procedure (WLTP). Figures shown may include options which are not available in Ireland.

# Mercedes-AMG GT 63 4MATIC+

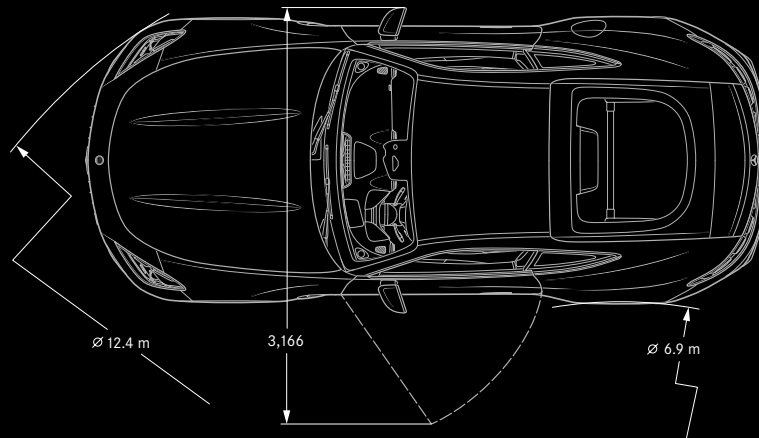
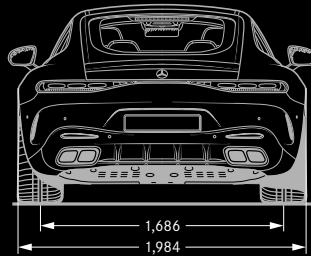
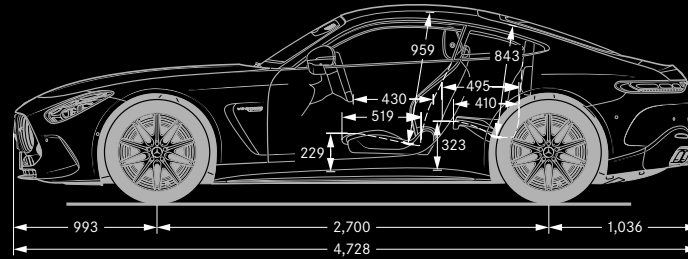
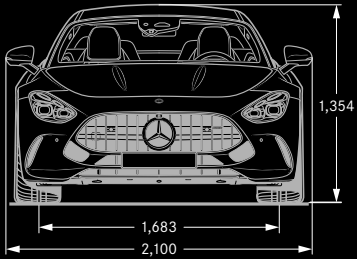

All measurements in millimetres. The dimensions shown are mean values and apply to standard-specification, unladen vehicles



# Mercedes me

Welcome to your Mercedes-Benz world.

Imagine if ...you could connect with your Mercedes-Benz? With Mercedes me connect, you can! Mercedes me connect offers you new connectivity services that make driving more comfortable and incorporates your car into your personal lifestyle.

## Standard Services

- Maintenance Management
- Telediagnosics
- Breakdown Management
- Accident Recovery
- Mercedes-Benz Emergency Call System

## Remote Online Services<sup>1</sup>

- Remote Retrieval of Vehicle Status (fuel level, tyre pressure etc.)
- Parked Vehicle Locator
- Vehicle Tracker
- Geofencing
- Door lock / unlock function

<sup>1</sup> Can be used with Remote Online special feature.





Getting connected is easy. Just set up your Mercedes me account and get in touch with your Mercedes-Benz dealer to connect your vehicle to your profile to access your Mercedes me connect services.

Contact your dealer to get connected, or go to [www.mercedes.me](http://www.mercedes.me) for more details.

Follow us on the following social media channels:

 [facebook.com/MercedesBenzIreland](https://facebook.com/MercedesBenzIreland)

 [instagram.com/mercedesbenz\\_ireland](https://instagram.com/mercedesbenz_ireland)

 [linkedin.com/company/motor distributors ltd](https://linkedin.com/company/motor-distributors-ltd)

 [twitter.com/MB\\_IRELAND](https://twitter.com/MB_IRELAND)

 [youtube.com/mercedesbenzireland](https://youtube.com/mercedesbenzireland)

 [pinterest.com/mercedesbenzire](https://pinterest.com/mercedesbenzire)

Motor Distributors Ltd.  
Naas Road  
Dublin 12  
Ireland  
[www.mercedes-benz.ie](http://www.mercedes-benz.ie)

Information correct at time of going to print. Prices and specifications are subject to change without prior notice. Prices quoted do not include dealer and delivery related charges. Images are for illustrative purposes only, actual product may vary. For more specific information in relation to the range of models, features, optional extras, colours and services available please speak to your local authorised Mercedes-Benz dealer.