



The new GLS

Price List from 1st January to 30th March 2025

Mercedes-Benz



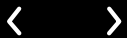

Welcome

At Mercedes-Benz we appreciate the importance of detail. Over the following pages you'll find model prices and a breakdown of standard and optional equipment, as well as details of the attractive finance offers and benefits that are available to every Mercedes-Benz driver.

We have highlighted some of the best styling features both inside and out, some of the new technology features and some body styling options which all combine to give you a unique driving experience. To experience a full listing of what is available; please speak directly to your local Mercedes-Benz Dealer.

Of course, some things have to be experienced to be truly appreciated, such as the qualities that set a Mercedes-Benz apart, which is why we'd like to invite you for a test drive at your local Mercedes-Benz Dealership. Discover the location and the contact details of your local Mercedes-Benz Dealership at **www.mercedes-benz.ie**



Some of the model features, optional extras and colours shown may not be available, or may only be available in a different specification, or at a different price.



Some of the model features, optional extras and colours shown may not be available, or may only be available in a different specification, or at a different price.

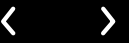

Some of the model features, optional extras and colours shown may not be available, or may only be available in a different specification, or at a different price.



Some of the model features, optional extras and colours shown may not be available, or may only be available in a different specification, or at a different price.

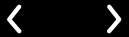

Some of the model features, optional extras and colours shown may not be available, or may only be available in a different specification, or at a different price.



Some of the model features, optional extras and colours shown may not be available, or may only be available in a different specification, or at a different price.

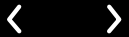

Some of the model features, optional extras and colours shown may not be available, or may only be available in a different specification, or at a different price.

Model prices

Petrol

Model Description	CO2	VRT Rate	Road Tax	CC	BHP	Price*
GLS 450 4MATIC	191 - 600	41.00%	€2,400	2999	367	€160,280
GLS 450 4MATIC AMG Line	191 - 600	41.00%	€2,400	2999	367	€170,450

Diesel

Model Description	CO2	VRT Rate	Road Tax	CC	BHP	Price*
GLS 450 4MATIC	191 - 600	41.00%	€1,250	2989	367	€162,535
GLS 450 4MATIC AMG Line	191 - 600	41.00%	€1,250	2989	367	€172,705

Mercedes-AMG

Model Description	CO2	VRT Rate	Road Tax	CC	BHP	Price*
MERCEDES-AMG GLS 63 4MATIC+	191 - 600	41.00%	€2,400	3982	612	€268,815

Mercedes-Maybach

Model Description	CO2	VRT Rate	Road Tax	CC	BHP	Price*
MERCEDES-AMG GLS 63 4MATIC+	191 - 600	41.00%	€2,400	3982	557	€273,345



GLS

—
Technology

Mercedes-Benz User Experience (MBUX)

Transforming the in-car user experience, thanks to MBUX: Controlled via voice or touch input, the innovative infotainment system can over time even predict personal habits thanks to artificial intelligence.



Multi-gesture touchpad control

MBUX multimedia system with DAB digital radio



Voice control

- Activated by the keywords “Hey Mercedes”, the new intelligent voice control LINGUATRONIC¹ lets you control many of the infotainment functions, including destination input, phone calls or music selection
- MBUX is able to understand different accents and will adjust to you over time
- MBUX even understands indirect commands. Feeling chilly? Just say “Hey Mercedes, I feel cold” and MBUX will adjust the temperature for you

Touch inputs

- Beside voice control you can operate MBUX via touchscreen, the touchpad on the centre console, as well as touch control buttons on the steering wheel
- The touchpad recognises your handwriting should you wish to enter addresses or phone numbers silently

Personalisation

- Turn the new GLS into your very own Mercedes-Benz by personalising driving modes, radio stations and much more
- Your personal settings can be saved in up to seven different profiles, making your driving experience the best one possible
- Thanks to artificial intelligence, MBUX is able to learn and adapt over time. It will be able to predict your personal habits, such as navigation for frequently-driven routes, or the radio station you like to listen to on your way home from work

Maintenance and service

- Wondering when the next service is due? Or how much further you can drive until you need to stop at a petrol station? Just ask your MBUX – it will tell you the answer

¹LINGUATRONIC off-board functions are currently only available for three years

Driving Assistance package

The **Driving Assistance package Plus¹** contains a range of highly intelligent features to help you stay safe on the road – by making the drive more effortless, by warning of danger, and by taking steps to protect you in an emergency.

From* €6,191



Active Blind Spot Assist can warn the driver of vehicles in the blind spot during a lane change and can help to avoid a collision by means of one-sided braking intervention

Active Braking Assist with cross-traffic function can help to avoid accidents with vehicles ahead, crossing traffic and also pedestrians, and/or mitigate their consequences

Active Distance Assist DISTRONIC helps maintain the desired distance from the vehicle in front

Active Emergency Stop Assist: immediate emergency braking if evasion is impossible

Active Lane Keeping Assist

Active Speed Limit Assist ensures detected speed limits are automatically adopted as the set speed for Active Distance Assist DISTRONIC

Active Steering Assist: targeted steering intervention to prevent unintentional drifting out of lane

Active Stop-and-Go Assist

Evasive Steering Assist can support the driver in making evasive manoeuvres if, in a dangerous situation, he/she moves to avoid any pedestrian detected by the system

Pedestrian warning function near pedestrian crossings

PRE-SAFE® Impulse Side moves occupants away from doors just before an imminent side impact

PRE-SAFE® PLUS: when a rear-end collision threatens, PRE-SAFE® PLUS can initiate preventive measures, including warning following traffic and locking the brakes on standstill

Route-based speed adjustment: adaption of speed before curves, roundabouts and junctions

Traffic Sign Assist



¹Our driver assistance and safety systems are aids and do not relieve you of your responsibility as the driver. Please take note of the information in the Owner's Manual and the system limits which are described therein

* Price subject to vehicle specification and VRT rate. PWT Advanced Plus Package required.

Mercedes me connect

Stay connected any time, anywhere.

Mercedes *me*

Mercedes me is a range of innovative online services designed to enhance your Mercedes-Benz experience. Accessible via mobile, tablet or PC, Mercedes me lets you enjoy the highest standards of care and support, in a way that integrates seamlessly with your busy lifestyle.

Safety and Service – Mercedes me connect helps to keep you and your car safe

Check your car's oil level, tyre pressure and fuel from your phone so you'll be ready for every journey.

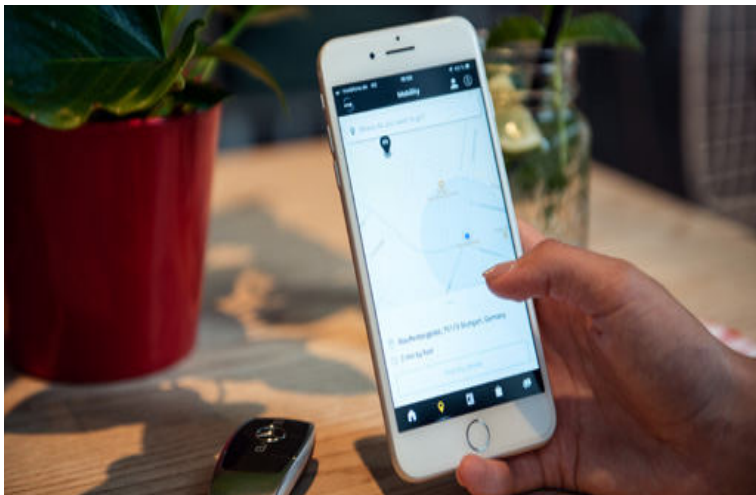

Live Traffic Information, Parked Vehicle Locator and much more with Mercedes me connect

Forgot where you've parked? Parked Vehicle Locator¹ will show you exactly where your car is as long as you're in a 1.5 km radius of where you parked. Real-time traffic data and dynamic route with shorter journey times.

Comfort – connect to your car anytime, anywhere

Forgot to lock your car? With Remote Car Lock² you will receive a notification on your smartphone to let you know. With one tap, you can lock and unlock your vehicle so you never have to worry.

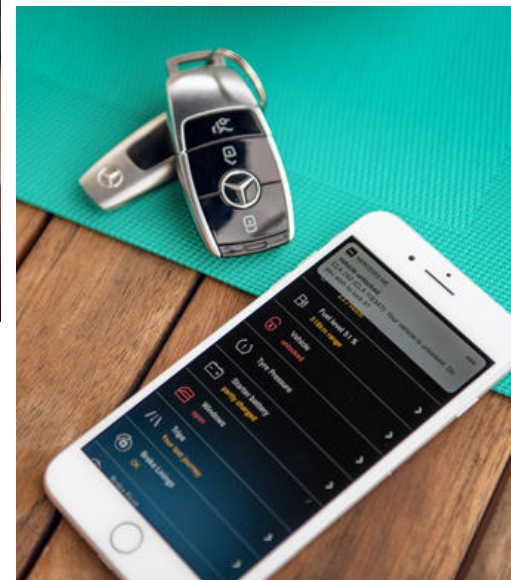

¹Available on all GLS models with extended connectivity plus Images shown are for illustration purposes only

< >

GLS Model lines overview



Standard Exterior »

Option shown: sodalite blue metallic (code 842)



AMG Line »

Option shown: MANUFAKTUR alpine grey (code 956)

Standard Exterior

Standard equipment highlights



Options shown: solid paint black (040)



Options shown: solid paint black (040)

Exterior

(20-inch) 5-twin-spoke light-alloy wheels painted tremolite grey with a high-shine finish (26R)

AIRMATIC air suspension with level adjustment and Adaptive Damping System

Anti-theft Alram System (GUARD 360 Vehicle Protection)

Blind Spot Detection

EASY-PACK powered tailgate

KEYLESS-GO Comfort package

Mirror Package

MULTIBEAM LED headlights with Adaptive Highbeam Assist Plus

Panoramic glass sunroof

Privacy glass

Roof rails – chrome

Summer tyres





Interior

Ambient lighting –64 colours

Centre armrests – rear, folding

Knee Airbag

Memory package

Roof liner in crystal grey fabric

Seats – front seats with 4 way lumbar support

Seats – front seats heated

Seats – electrically adjustable front seats

Seats - electrically adjustable second seat row

Seats - rear seats, third row (7 seats) - electrically folding and raising with EASY-ENTRY system power release

THERMOTRONIC luxury automatic climate control (4-Zone)

USB Package (7 USB Ports)

Safety, Communications and In-Car Entertainment

5G communications module

Active Lane Keeping Assist

Active Brake Assist

Parking package with 360° camera

Pre-installation for MBUX Entertainment

Traffic Sign Assist

Wireless charging² – front

²Compatible mobile phone required



Trim and Upholstery

High-gloss brown linestructure lime wood trim

Rough leather black

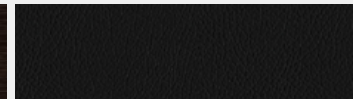
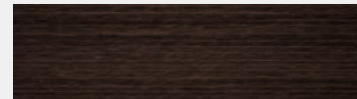

AMG Line

Standard equipment highlights



Options shown: solid paint black (040)



Options shown: solid paint black (040)

In addition to/replacement of Standard Exterior

Exterior

(21-inch) AMG 5-twin-spoke light-alloy wheels aerodynamically optimised, painted titanium grey with a high-sheen finish (RWF)

AMG bodystyling consisting of...

- AMG front apron with striking, sporty air outlets in the wheel arch linings.
- Flared wheel arches at front and rear, painted in the vehicle colour.
- AMG side sill panels painted in vehicle colour.
- AMG rear apron with diffuser-look insert in black and trim strip in chrome.





Interior

AMG floor mats in black velour with "AMG" lettering

AMG brushed stainless steel sports pedals

Multifunction sport steering wheel featuring...

- 3-spoke design, with flattened lower section and perforated grip area.
- Finished in black nappa leather with black topstitching.
- Touch control panels, gearshift paddles and steering wheel bezel in silver chrome.

Trim and Upholstery

High-gloss brown linestructure lime wood trim



Leather - black



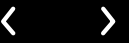

GLS

Mercedes-AMG

Mercedes-AMG GLS 63 4MATIC+



The 4.0-litre V8 biturbo engine and the dynamic AMG Performance 4MATIC+ all-wheel drive with fully variable torque distribution provide the Mercedes-AMG GLS 63 4MATIC+ with breathtaking propulsion. The integral starter-generator delivers additional output by boosting and recovers energy highly efficiently through recuperation. The performance of the V8 engine with 612 hp is thus additionally boosted by up to 16 kW. The 48 volt onboard electrical system dependably delivers energy, as the additional compressor supplies torque from just above idling speed. For optimum handling and extremely agile response, even when pushing the car to its sporty limits.

The driver also benefits from the advantages of both a traction-oriented all-wheel drive system and a purely rear-wheel drive system. The power delivery and output are translated into pure driving pleasure by technical details such as AMG Dynamics, AMG Speedshift TCT 9G and the variable AMG Performance exhaust system.



< >

GLS

Mercedes-Maybach



< >

Mercedes-Maybach GLS Model lines overview

MAYBACH

Mercedes-Maybach GLS 600 4MATIC »



Mercedes-Maybach GLS 600 4MATIC

Standard equipment highlights

MAYBACH



Options shown: solid paint black (040)



Exterior

22" Maybach light-alloy wheels – multi-spoke design in high-gloss black with a high-shine finish, including fully integrated wheel bolt cover (code R63)

Air inlet grilles feature a Maybach pattern

AIRMATIC air suspension with level adjustment and Adaptive Damping System

MAGIC VISION CONTROL including heated wipers

Maybach electrically extending running boards

Maybach-specific tailpipe trim, in a high-gloss chrome finish with horizontal trim

inserts
Panoramic glass sunroof

Power closing doors





Interior

AIR BALANCE package

Door sills with 'Maybach' lettering

ENERGIZING Plus package

Load compartment cover with Maybach emblem

Memory package

Multicontour, climatized front and rear seats with massage function

Pedal assembly in brushed stainless steel with Maybach emblem

THERMOTRONIC luxury automatic climate control

Communications and In-Car Entertainment

Burmester® surround sound system

Exclusive Trim Package

MBUX Interior Assistance

Smartphone integration¹ including Apple CarPlay® and Android Auto™

Widescreen cockpit comprising two displays, each with a 12.3-inch screen diagonal and a specific 'Maybach' display style

Wireless charging¹, front



Panoramic glass sunroof

Safety and Assistance Systems

Driving Assistance package²

Parking package with 360° camera

GUARD 360° vehicle protection

Trim and Upholstery

Anthracite open-pore oak wood trim elements (H31)

Maybach Exclusive nappa leather – black

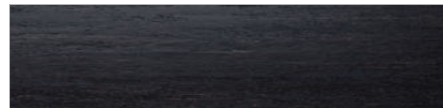

¹Compatible mobile phone required

²Our driver assistance and safety systems are aids and do not relieve you of your responsibility as the driver. Please take note of the information in the Owner's Manual and the system limits which are described therein

Upholstery (GLS)

● Standard □ Option



201 rough leather black



215 leather macchiato beige / black



224 bahia bown / black



225 catalana beige / black

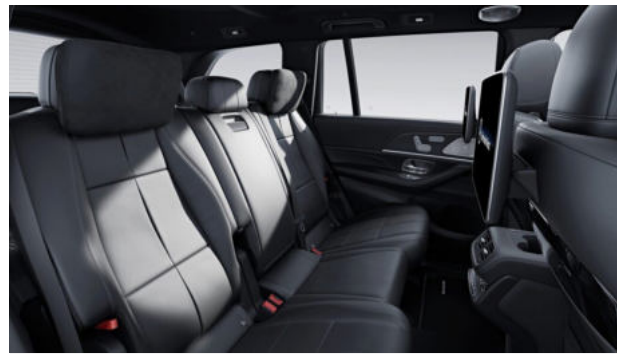

951 nappa leather black



*Please use our online car configurator to ensure the selected upholstery is compatible with your chosen paint colour.

Upholstery (GLS Maybach)

● Standard □ Option



511 Maybach exclusive nappa leather black



514 Maybach exclusive nappa leather MANUFAKTUR mahogany brown / macchiato beige



519 Maybach exclusive nappa leather MANUFAKTUR crystal white / silver grey pearl



MANUFAKTUR Leather package

The MANUFAKTUR Leather package enhances the exciting Maybach aesthetics of the interior with exquisite materials.

MANUFAKTUR Leather package (code U61) – designed and priced as a package, including items as listed.

Only available for Mercedes-Maybach models

From* €43,353

Consisting of:

Front seat console on driver and front passenger sides in nappa leather

MANUFAKTUR roof liner in nappa leather with topstitching including leather-covered sun visors, grab handles, map pockets, and pillars

Two upholstered cushions with 'Maybach' logo

Two upholstered cushions for the leg rests of the Executive seats

Window frame lining in the boot cover in ARTICO man-made leather



Option shown: Exclusive nappa leather in MANUFAKTUR crystal white/silver grey pearl (code 519A)



Trim options

● Standard □ Option



high-gloss brown linestructure lime wood trim (04H) ●



MANUFAKTUR high-gloss black flowing lines piano lacquer (H11) □



Brown open-pore walnut wood trim (H22) □



Anthracite open-pore oak wood trim elements (H31)* □



Bushed aluminum trim with light longitudinal grain (H46) □



AMG carbon fiber trim (H86) □

* Anthracite open-pore oak wood trim elements (H31) is standard for Mercedes-Maybach models.

Wheel options (standard exterior)

● Standard □ Option



(20-inch) 5-twin-spoke light-alloy wheels, painted tremolite gray with a high-sheen finish **(26R)** ●



(20-inch) 5-twin-spoke light-alloy wheels, aerodynamically optimized, painted high-gloss black with a high-sheen finish **(R33)** □



(21-inch) 5-triple-spoke light-alloy wheels, painted high-gloss himalayas gray with a high-sheen finish **(95R)** □

Wheel options (AMG Line exterior)

● Standard □ Option



(21-inch) AMG 5-twin-spoke light-alloy wheels, aerodynamically optimized, painted titanium gray with a high-sheen finish (**RWF**)



(21-inch) AMG 5-twin-spoke light-alloy wheels, aerodynamically optimized, painted high-gloss black with a high-sheen finish (**RWH**)



(22-inch) AMG multi-spoke light-alloy wheels, painted high-gloss titanium gray with a high-sheen finish (**RPA**)



(22-inch) AMG multi-spoke light-alloy wheels, painted high-gloss black with a high-sheen finish (**RPB**)



(23-inch) AMG 5-twin-spoke light-alloy wheels, painted high-gloss black with a high-sheen finish (**RPK**)



(23-inch) AMG 5-twin-spoke light-alloy wheels, painted high-gloss black with a high-sheen finish (**RWQ**)

Wheel options (Mercedes-Maybach)

● Standard □ Option



(22-inch) Maybach multi-spoke light-alloy wheels, painted high-gloss black with a high-shine finish **(R63)** ●



(23-inch) Maybach 5-hole forged wheels, ceramically high-shine-polished **(R53)** □



(23-inch) Maybach multi-spoke forged wheels High-gloss polished ceramic **(R65)** ●

Package options

Special equipment <small>Sometimes equipment will be replaced by an upgrade.</small>	Advanced Package <small>always included</small>	Advanced-Plus Package <small>From* €5,567</small>	Premium-Plus Package <small>From* €15,110</small>
THERMOTRONIC automatic climate control	✓	✓	✓
Parking Package with 360-degree camera	✓	✓	✓
KEYLESS-GO Comfort Package	✓	✓	✓
Double sunblind	✓	✓	✓
Preinstallation for digital key transfer	✓	✓	✓
Panoramic sliding sunroof	✓	✓	✓
Smartphone integration	✓	✓	✓
Blind Spot Assist	✓	✓	✓
Wireless charging system for mobile devices in the front	✓	✓	✓
MULTIBEAM LED	✓	×	×
Heat-insulating dark-tinted glass	✓	✓	✓
Heated front seats	✓	×	×
Climatised front seats	×	✓	✓
multicontour front seats	×	×	✓
Heated rear seats	×	×	✓
2 USB ports in the rear	✓	✓	✓
Adaptive Highbeam Assist Plus	✓	✓	×
MBUX augmented reality for navigation	×	✓	✓
Power closing	×	✓	✓
Burmester® surround sound system	×	✓	✓
AIR BALANCE Package	×	×	✓
THERMOTRONIC automatic climate control in the rear	×	×	✓
Head-up display	×	×	✓
ENERGIZING Package	×	×	✓
MBUX Interior Assistant	×	×	✓
Temperature-controlled cup holder	×	×	✓
Surround lighting with animated projection of the Mercedes-Benz pattern	×	×	✓
MBUX Interior Assistant	×	×	✓
Temperature-controlled cup holder	×	×	✓
Surround lighting with animated projection of the Mercedes-Benz pattern	×	×	✓

* Price subject to vehicle specification and VRT rate.

Colour options

Standard Optional



197 obsidian black metallic No-cost option



922 high-tech silver metallic No-cost option



992 selenite grey metallic No-cost option



996 MANUFaktur hyacinth red metallic Optional



842 sodalite blue metallic No-cost option



885 MANUFaktur opalite white bright Optional



956 MANUFaktur alpine grey Optional



040 black non metallic No-cost option



149 polar white non metallic No-cost option

Please note that, owing to limitations of on-screen representation, paint colours may differ from those shown

Trailer Coupling with ESP trailer stabilisation

Offers an electronically folding tow bar which increases the towing capacity up to 3,500 kg.

(code 550) – designed and priced as a package, including items as listed.

Available for all models.

From* €1,258

Consisting of:

Electronically folding tow bar (includes 13-pin socket;
ESC: Electronic Stability Control)

Increased towing capacity – max. 3,500 kg



Technical data

● Standard – Not available

Model	GLS 450 d 4MATIC	GLS 450 4MATIC	Mercedes-AMG GLS 63 4MATIC+	Mercedes-Maybach GLS 600 4MATIC
Engine				
Fuel delivery	Diesel	Petrol	Petrol	Petrol
Total displacement	cc 2,989	2,999	3,982	3,982
Arrangement/cylinders/valves	in-line/6/24	in-line/6/24	V/8/32	V/8/32
Power ¹	hp (kW) at rpm			
Combustion engine	367 (270)/4,000	381 (280)/5,800–6,100	612 (450)/5,750–6,500	557 (410)/6,000–6,500
Electric motor	–	–	22 (16)	22 (16)
Torque ¹	Nm at rpm	500/1,800–5,000	850/2,500–4,500	730/2,500–5,000
Compression ratio	15.5:1	10.0:1	8.6:1	8.6:1
Emissions standard	EURO 6D-ISC-FCM	EURO 6D-ISC-FCM	EURO 6D-ISC-FCM	EURO 6D-ISC-FCM
Transmission				
9G-TRONIC 9-speed automatic	●	●	–	●
AMG SPEEDSHIFT TCT 9-speed sports transmission	–	–	●	–
Performance				
Acceleration 0–100 km/h	sec 6.1	6.1	4.2	4.9
Top speed	km/h 250	250	280	280

¹Figures according to Directive 80/1269/EEC in the currently applicable version

Technical data

Model		GLS 450 d 4MATIC	GLS 450 4MATIC	Mercedes-AMG GLS 63 4MATIC+	Mercedes-Maybach GLS 600 4MATIC
Weights and capacities					
Kerb weight ²	kg	2,820–2,842	2,720–2,742	2,845	2,961–3,046
Perm. Gross Vehicle Weight	kg	3,300	3,220	3,395	3,270
Towing capacity – unbraked/braked	kg	750/3,500	750/3,500	750/3,300	750/3,500
Boot capacity – seats up/seats down	l	355/2,400	355/2,400	355/2,400	520
behind 1st row of seats	l	1,470	1,470	–	–
behind 2nd row of seats	l	890	890	–	–
behind 3rd row of seats	l	355	355	–	–
Fuel tank capacity/of which reserve	l	90/9	90/9	90/12	90/12
Turning circle	m	12.54	12.54	13.10	12.54
Wading depth	mm	500	500	–	–
Fuel consumption^{3,4,5}					
Combined (consumption dependent on chosen optional equipment)	l/100 km mpg	8.8 32.1	11.4–11.2 24.8–25.2	13.4 21.1	14.0–14.1 20.2–20.0

²Mass of the vehicle in running order with at least 90% full fuel tank, plus the mass of the driver (estimated by law at 75 kg), fuel and fluids, equipped with the standard equipment as specified by the manufacturer as well as, where applicable, the mass of the body, cab, trailer coupling and spare wheel(s) as well as tools. Optional extras, additional equipment and accessories can influence the weight, residual payload, rolling resistance, aerodynamics, etc., and therefore also affect the consumption/VRT Rate/CO₂ values ³All figures are based on a standard specification with the smallest tyre size ⁴The choice of wheels and transmission may affect CO₂ emissions and corresponding VRT Rate ⁵The indicated values were determined according to the prescribed measurement method – Worldwide Harmonised Light Vehicle Test Procedure (WLTP). Figures shown may include options which are not available in Ireland.

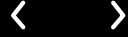

GLS450/d

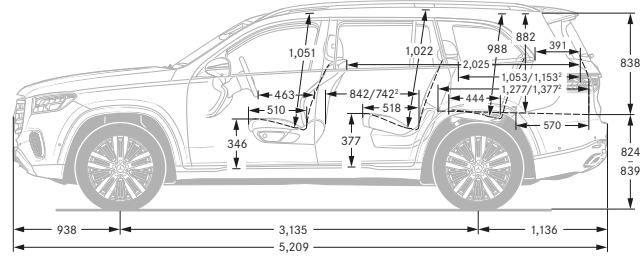
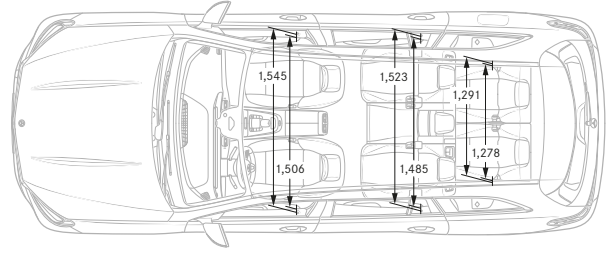
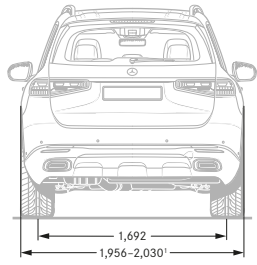
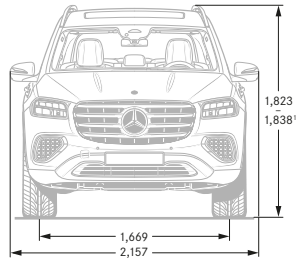

Mercedes-AMG GLS63 4MATIC+

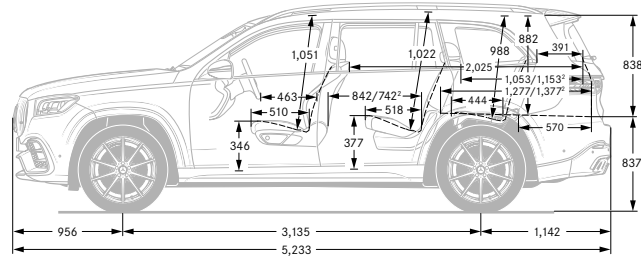
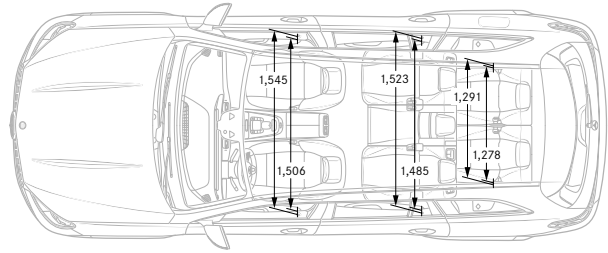
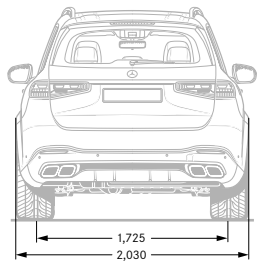
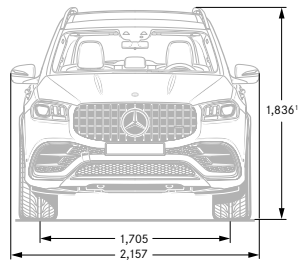

*With minimum to maximum-size tyres at normal or highway level ?With rear bench seat pushed forward 100 mm All measurements in millimetres. The dimensions shown are mean values and apply to standard-specification, unladen vehicles

Mercedes-Maybach GLS 600 4MATIC

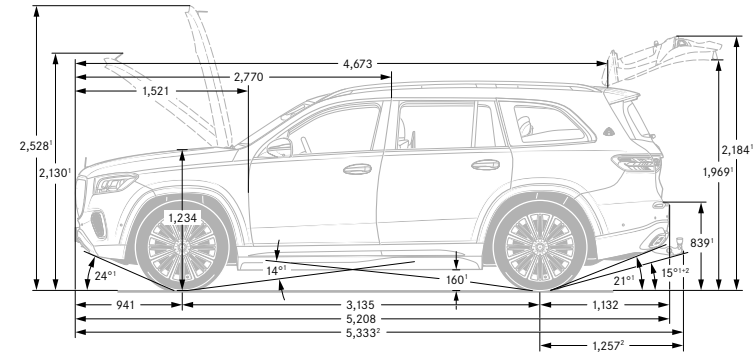
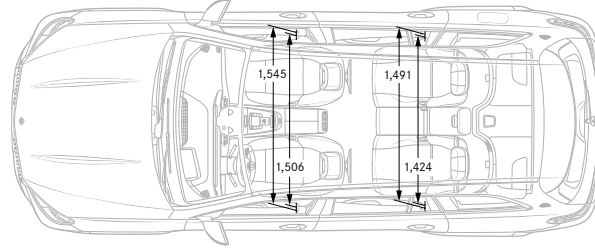
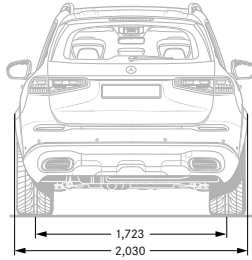
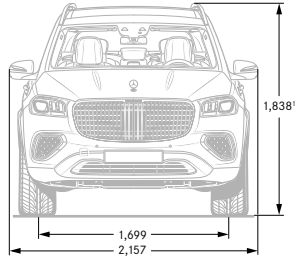

¹With "On-road" suspension setting All measurements in millimetres. The dimensions shown are mean values and apply to standard-specification, unladen vehicles

GLS 450/d

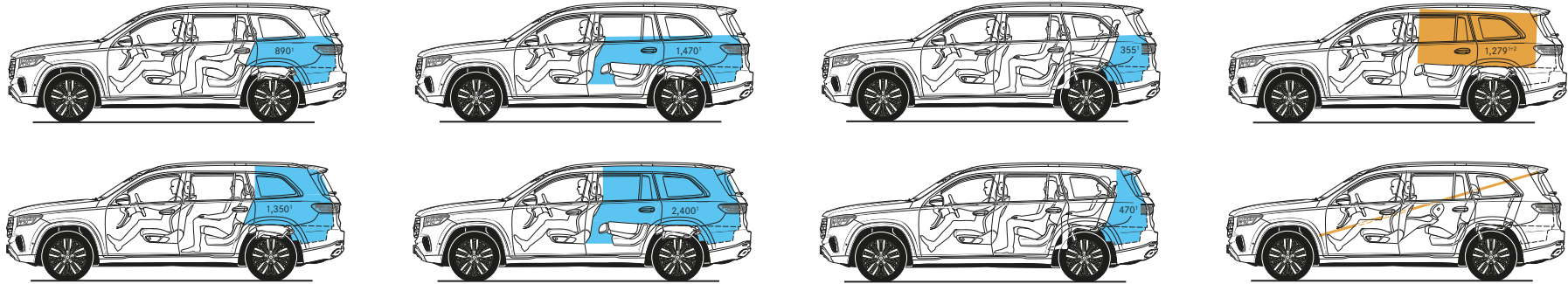

Luggage compartment capacity according to guideline ISO 3832:2002-06, Luggage compartment capacity may differ depending on optional extras

¹Volume in litres

²Largest cuboid: dimensions 1,898 × 1,015 × 664 mm, volume 1,279 litres

³Longest board: dimensions 3,546 × 400 × 30 mm

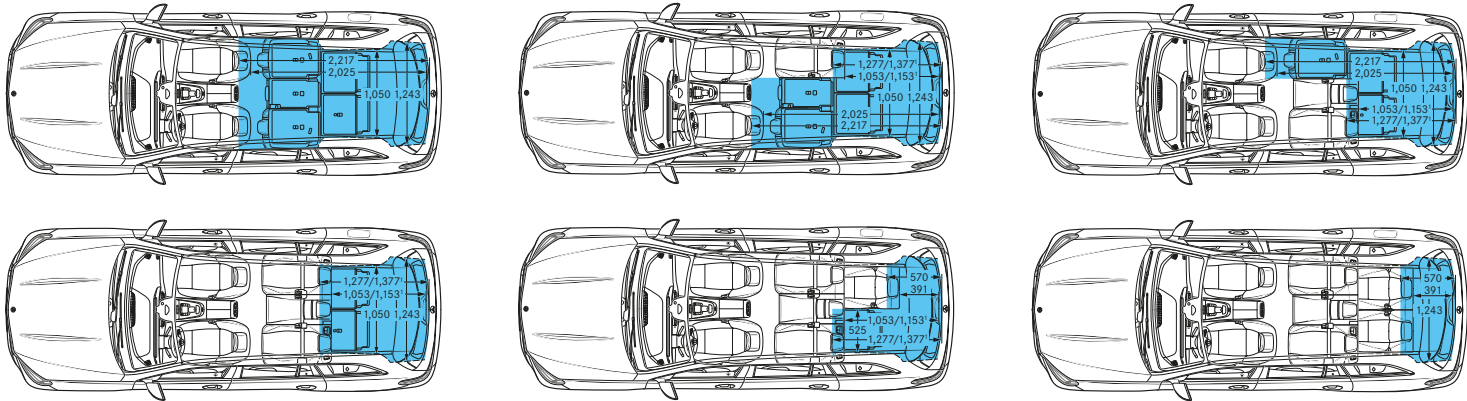

⁴With rear bench seat pushed forward 100 mm



Mercedes me

Welcome to your Mercedes-Benz world.

Imagine if ...you could connect with your Mercedes-Benz? With Mercedes me connect, you can! Mercedes me connect offers you new connectivity services that make driving more comfortable and incorporates your car into your personal lifestyle.

Standard Services

- Maintenance Management
- Telediagnosics
- Breakdown Management
- Accident Recovery
- Mercedes-Benz Emergency Call System

Remote Online Services¹

- Remote Retrieval of Vehicle Status (fuel level, tyre pressure etc.)
- Parked Vehicle Locator
- Vehicle Tracker
- Geofencing
- Door lock / unlock function

¹ Can be used with Remote Online special feature.





Getting connected is easy. Just set up your Mercedes me account and get in touch with your Mercedes-Benz dealer to connect your vehicle to your profile to access your Mercedes me connect services.

Contact your dealer to get connected, or go to www.mercedes.me for more details.

Follow us on the following social media channels:

 facebook.com/MercedesBenzCarsIreland

 instagram.com/mercedesbenz_cars_ireland

 linkedin.com/company/motor-distributors-ltd

 twitter.com/MercedesBenzIre

 youtube.com/mercedes-benzireland

Motor Distributors Ltd.
Naas Road
Dublin 12
Ireland
www.mercedes-benz.ie

Information correct at time of going to print. Prices and specifications are subject to change without prior notice. Prices quoted do not include dealer and delivery related charges. Images are for illustrative purposes only, actual product may vary. For more specific information in relation to the range of models, features, optional extras, colours and services available please speak to your local authorised Mercedes-Benz dealer.